

- > **Port size: 1/4" ... 1/2"**
(ISO G / NPT)
Namur or manifold
- > **Direct acting solenoid valve**
- > **High flow**
- > **12 bar inlet pressure**
- > **Reliable and long life, ideal for a one time installation**
- > **Control of pneumatic or hydraulic operated equipment**
- > **Certifications: ATEX, CSA, TR CU, IECEx, FM, CSA, CRN, CCOE, IN-METRO, KOSHA, NEPSI, PESO (CCOE), Japan ISHL**
- > **Environmental protection: NEMA 4X, IP66/X8**



Technical features

Medium:

Hydraulic and pneumatic – customer to specify and confirm compatibility

Operation:

Direct solenoid operated poppet valves

Mounting position:

Solenoid vertical

Flow:

0,6 Cv (8,7Kv) ... 3.3 Cv (46.4 Kv)

Port size:

G 1/4, 1/2 NPT, G 1/4, G 1/2
NAMUR or manifold versions

Operating pressure:

0 ... 12 bar (0 ... 174 psi)

Temperature:

Media:

-55 ... +90°C (-67 ... 194°F)

Ambient:

See table on page 2



Air supply must be dry enough to avoid ice formation at temperatures below +2°C (+35°F).

Materials:

Valve body, trim, coil housing and top cover:
stainless steel 1.4404 (316 L)
O-rings seats & seals: NBR

Other seal materials available on request

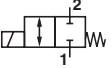
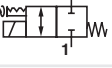
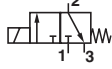
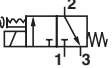
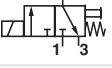
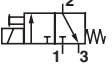
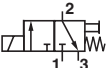
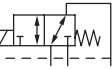
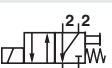
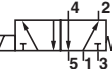
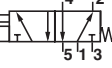
Technical data – standard models with conduit connection M20 x 1,5

Symbol	Port size	Function	Operating pressure (bar)	Manual override/reset	ATEX certification	Power consumption at 24 Vdc (W)	Ambient temperature	Weight (kg)	Dimension No.	Model
	1/4 NPT	2/2 NC	0 ... 12	Without	Ex II 2 GD, Exd IIC	3	T6 (-55 ... +50°C), T4 (+90°C max)	2,0	1	Y011AA1H1BS
	G 1/4	2/2 NC	0 ... 12	Without	Ex II 2 GD, Exd IIC	3	T6 (-55 ... +50°C), T4 (+90°C max)	2,0	1	Y011AE1H1BS
	1/4 NPT	2/2 NC	0 ... 12	JSMO*1)	Ex II 2 GD, Exd IIC	3	T6 (-55 ... +50°C), T4 (+90°C max)	2,0	2	Y011SA1H1BS
	G 1/4	2/2 NC	0 ... 12	JSMO*1)	Ex II 2 GD, Exd IIC	3	T6 (-55 ... +50°C), T4 (+90°C max)	2,0	2	Y011SE1H1BS
	1/4 NPT	3/2 UNI	0 ... 12	Without	Ex II 2 GD, Exd IIC	3	T6 (-55 ... +50°C), T4 (+90°C max)	2,0	3	Y013AA1H1BS
	G 1/4	3/2 UNI	0 ... 12	Without	Ex II 2 GD, Exd IIC	3	T6 (-55 ... +50°C), T4 (+90°C max)	2,0	3	Y013AE1H1BS
	1/2 NPT	3/2 UNI	0 ... 12	Without	Ex II 2 GD, Exd IIC	7,8	T6 (-55 ... +50°C), T4 (+90°C max)	2,5	4	Y013AA3H1BS
	G 1/2	3/2 UNI	0 ... 12	Without	Ex II 2 GD, Exd IIC	7,8	T6 (-55 ... +50°C), T4 (+90°C max)	2,5	4	Y013AE3H1BS
	1/4 NPT	3/2 UNI	0 ... 12	JSMO*	Ex II 2 GD, Exd IIC	3	T6 (-55 ... +50°C), T4 (+90°C max)	2,5	5	Y013SA1H1BS
	G 1/4	3/2 UNI	0 ... 12	JSMO*	Ex II 2 GD, Exd IIC	3	T6 (-55 ... +50°C), T4 (+90°C max)	2,5	5	Y013SE1H1BS
	1/4 NPT	3/2 UNI	0 ... 12	TPMP*1)	Ex II 2 GD, Exd IIC	3	T6 (-55 ... +50°C), T4 (+90°C max)	2,5	6	Y013TA1H1BS
	G 1/4	3/2 UNI	0 ... 12	TPMP*1)	Ex II 2 GD, Exd IIC	3	T6 (-55 ... +50°C), T4 (+90°C max)	2,5	6	Y013TE1H1BS
	1/4 NPT	3/2 UNI	0 ... 12	PBMO*1)	Ex II 2 GD, Exd IIC	3	T6 (-55 ... +50°C), T4 (+90°C max)	2,0	7	Y013PA1H1BS
	G 1/4	3/2 UNI	0 ... 12	PBMO*1)	Ex II 2 GD, Exd IIC	3	T6 (-55 ... +50°C), T4 (+90°C max)	2,0	7	Y013PE1H1BS
	1/2 NPT	3/2 UNI	0 ... 12	PBMO*1)	Ex II 2 GD, Exd IIC	7,8	T6 (-55 ... +50°C), T4 (+90°C max)	2,5	8	Y013CA3H1BS
	G 1/2	3/2 UNI	0 ... 12	PBMO*1)	Ex II 2 GD, Exd IIC	7,8	T6 (-55 ... +50°C), T4 (+90°C max)	2,5	8	Y013CE3H1BS
	1/2 NPT	3/2 UNI	0 ... 12	PBMR*1)	Ex II 2 GD, Exd IIC	3	T6 (-55 ... +50°C), T4 (+90°C max)	2,8	8	Y013PA3H1BS
	G 1/2	3/2 UNI	0 ... 12	PBMR*1)	Ex II 2 GD, Exd IIC	3	T6 (-55 ... +50°C), T4 (+90°C max)	2,8	8	Y013PE3H1BS
	Manifold	3/2 UNI	0 ... 12	Without	Ex II 2 GD, Exd IIC	3	T6 (-55 ... +50°C), T4 (+90°C max)	2,8	9	Y013AKFH1BS
	1/4 NPT NAMUR	3/2 UNI	0 ... 12	PBMR*1)	Ex II 2 GD, Exd IIC	3	T6 (-55 ... +50°C), T4 (+90°C max)	2,5	10	Y013PNAH1BS
	G 1/4 NAMUR	3/2 UNI	0 ... 12	PBMR*1)	Ex II 2 GD, Exd IIC	3	T6 (-55 ... +50°C), T4 (+90°C max)	2,5	10	Y013PNEH1BS
	1/4 NPT	5/2 UNI	0 ... 12	Without	Ex II 2 GD, Exd IIC	7,8	T6 (-55 ... +50°C), T4 (+90°C max)	2,8	11	Y015AA1H1BS
	G 1/4	5/2 UNI	0 ... 12	Without	Ex II 2 GD, Exd IIC	7,8	T6 (-55 ... +50°C), T4 (+90°C max)	2,8	11	Y015AE1H1BS
	NAMUR	5/2 UNI	0 ... 12	Without	Ex II 2 GD, Exd IIC	7,8	T6 (-55 ... +50°C), T4 (+90°C max)	2,3	14	Y015ANA1H1BS
	1/4 NPT	5/2 UNI	0 ... 12	PBMO*1)	Ex II 2 GD, Exd IIC	7,8	T6 (-55 ... +50°C), T4 (+90°C max)	2,3	12	Y015CA1H1BS
	G 1/4	5/2 UNI	0 ... 12	PBMO*1)	Ex II 2 GD, Exd IIC	2	T6 (-55 ... +50°C), T4 (+90°C max)	2,3	12	Y015CE1H1BS
	1/4 NPT	5/2 UNI	0 ... 12	PBMR*1)	Ex II 2 GD, Exd IIC	2	T6 (-55 ... +50°C), T4 (+90°C max)	2,5	13	Y015PA1H1BS
	G 1/4	5/2 UNI	0 ... 12	PBMR*1)	Ex II 2 GD, Exd IIC	7,8	T6 (-55 ... +50°C), T4 (+90°C max)	2,5	13	Y015PE1H1BS

*1) PBMR = Push button manual reset, PBMO = Push button manual override, JSMO = Jack screw manual override, TMRP = Tamperproof manual reset button

Option selector
Y★1★★ ★★ ★★ ★★ ★★ S

ATEX certification	Substitute
Ex d	O
Ex mbe	Z
Ex ia*	X
Operation	Substitute
2/2 NC	1
2/2 NO	2
3/2	3
5/2	5
Operation	Substitute
Automatic	A
Push button manual override	C
Push button manual reset	P
Tamper proof manual reset	T
Jackscrew manual override	S
Port size	Substitute
1/4 NPT	A1
G 1/4	E1
1/2 NPT	A3
G 1/2	E3
NAMUR	NA
Manifold	KF

Voltage / Signal	Substitute
24 V d.c.	B
50 V d.c.	C
110 V d.c.	D
125 V d.c.	E
24 V a.c.	G
110 V a.c.	J
220 /240 V a.c. (240 V)	M
120 V a.c.	T
Conduit / Signal connection	Substitute
20mm x 1.5mm ISO (F)	1
1/2 NPT (F)	2
Seat /seal material	Substitute
Nitrile (-55° ... +90 °C)	H
FKM (-20° ... +90 °C)	V

* For Zone 0 - see separate catalogue section.

Dimensions

Dimensions in mm
Projection/First angle

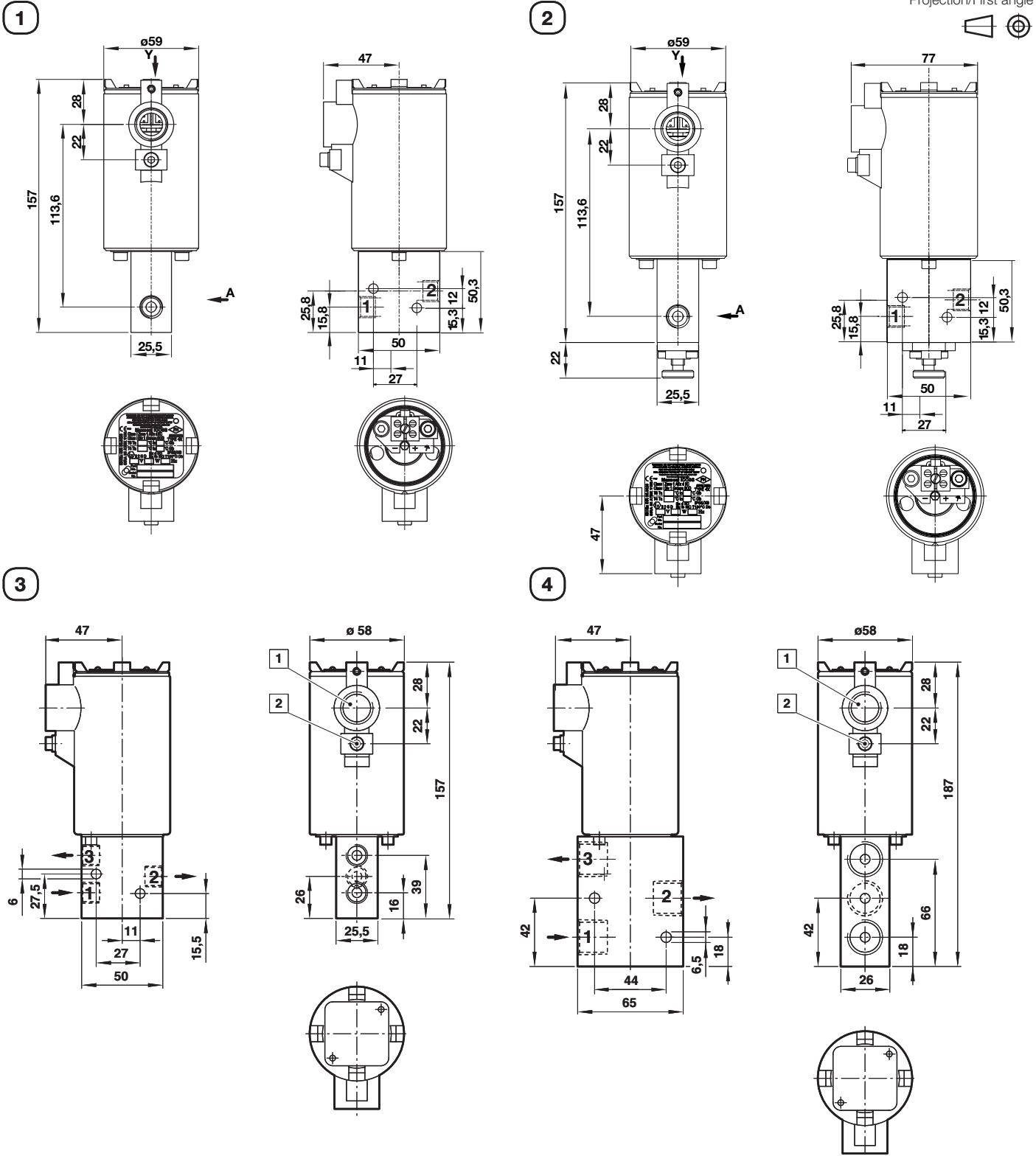

- 1 Conduit connection M20 x 1,5 or 1/2 NPT
- 2 External earth
- 5 Jack screw manual override (JSMO)

Dimensions in mm
Projection/First angle



5

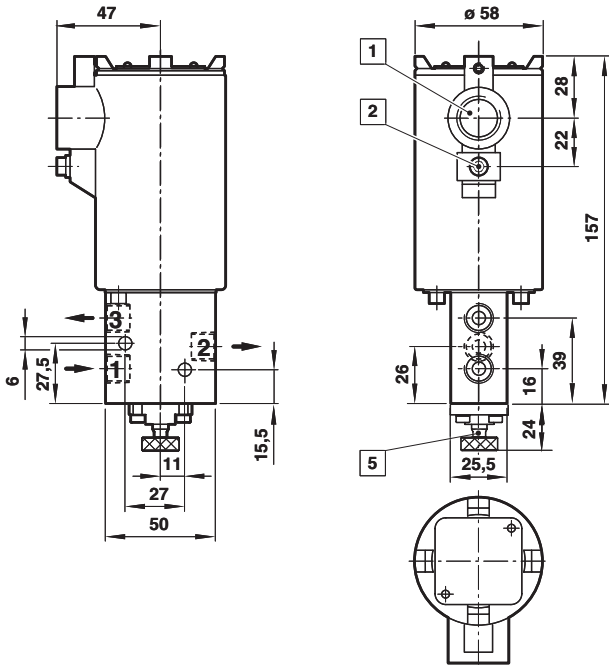

6

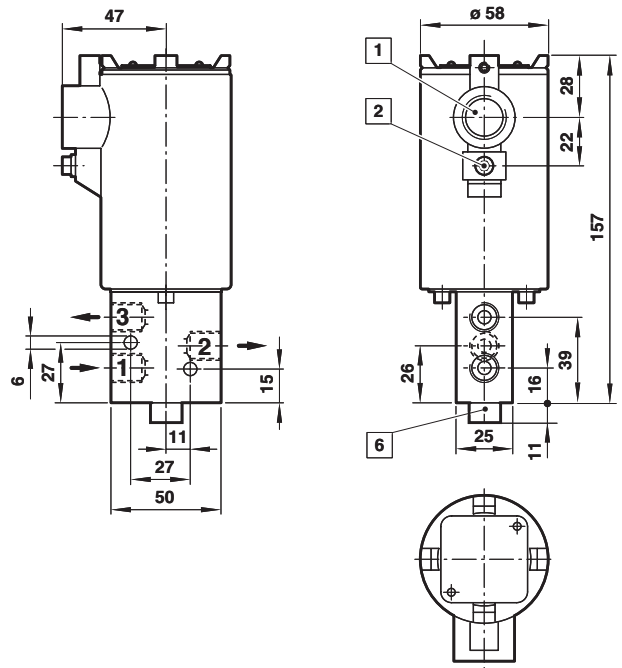

7

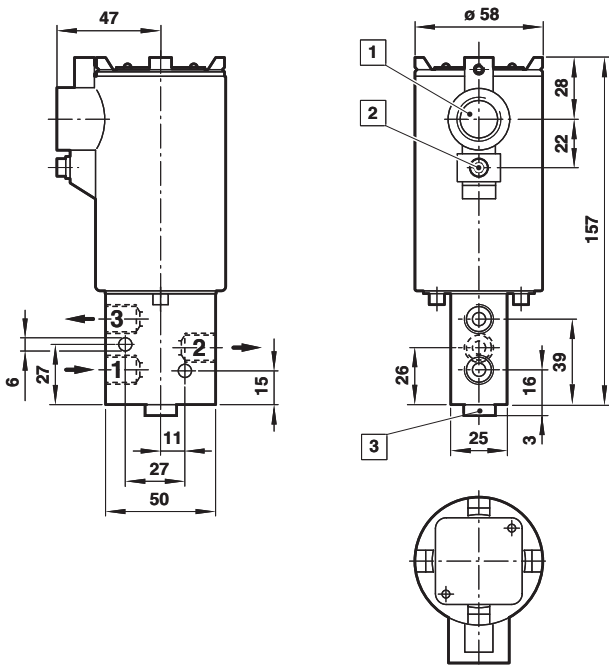

8

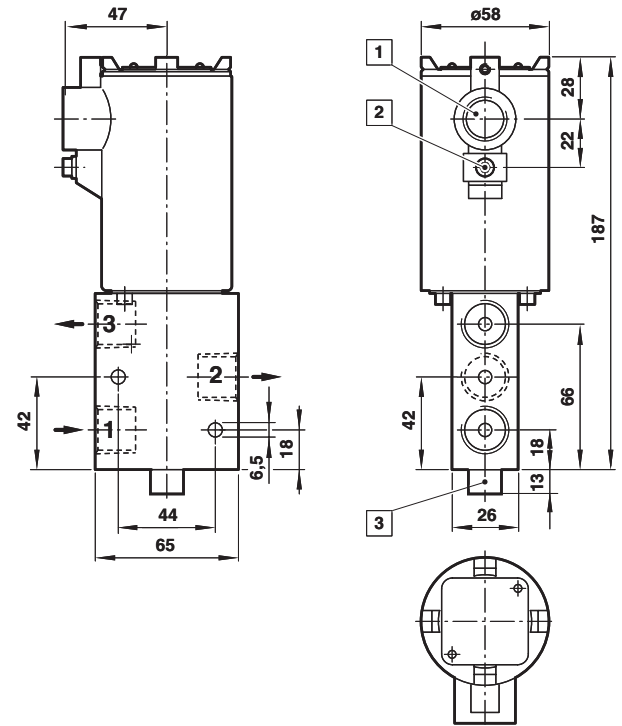

- 1 Conduit connection M20 x 1,5 or 1/2 NPT
- 2 External earth
- 3 Push button manual reset (PBMR)
- 4 Push button manual override (PBMO)
- 6 Tamer proof manual reset (TPMR)

9

Dimensions in mm
Projection/First angle

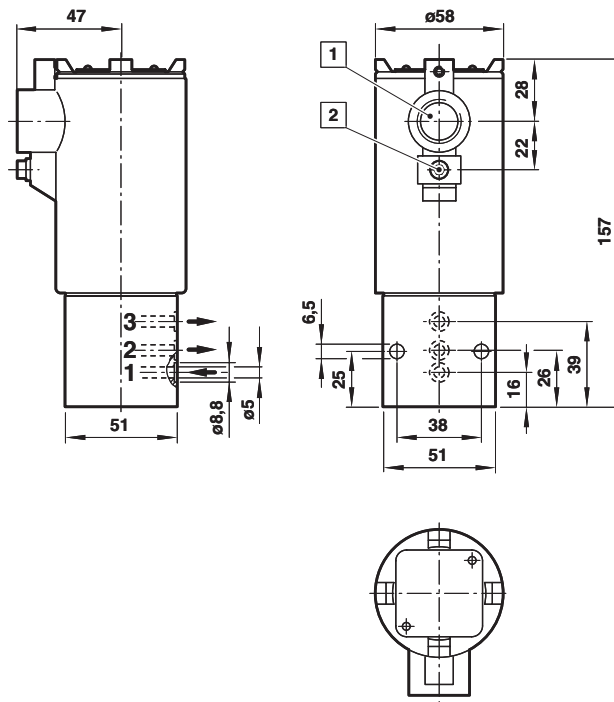

10

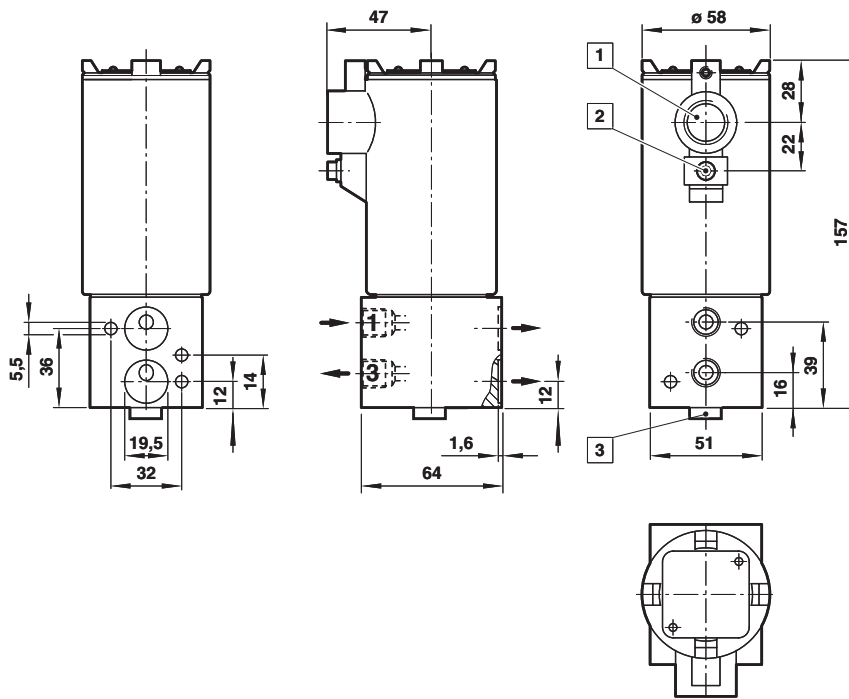

- 1 Conduit connection M20 x 1,5 or 1/2 NPT
- 2 External earth
- 3 Push button manual reset (PBMR)

Dimensions in mm
 Projection/First angle

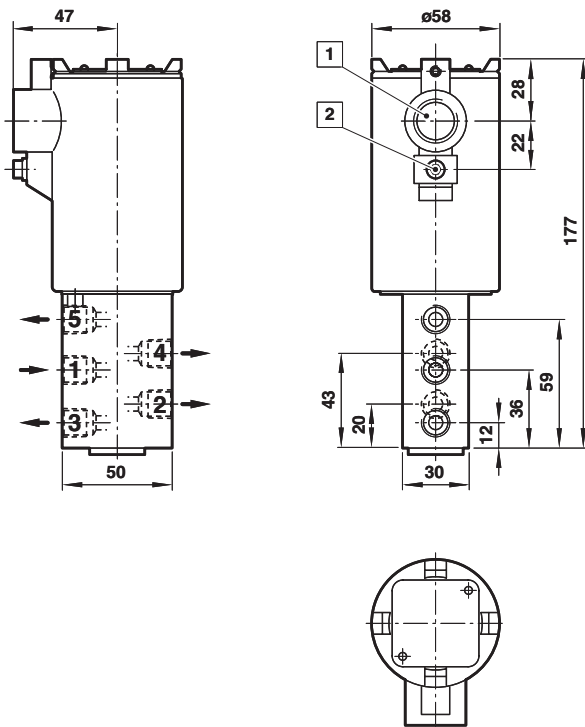
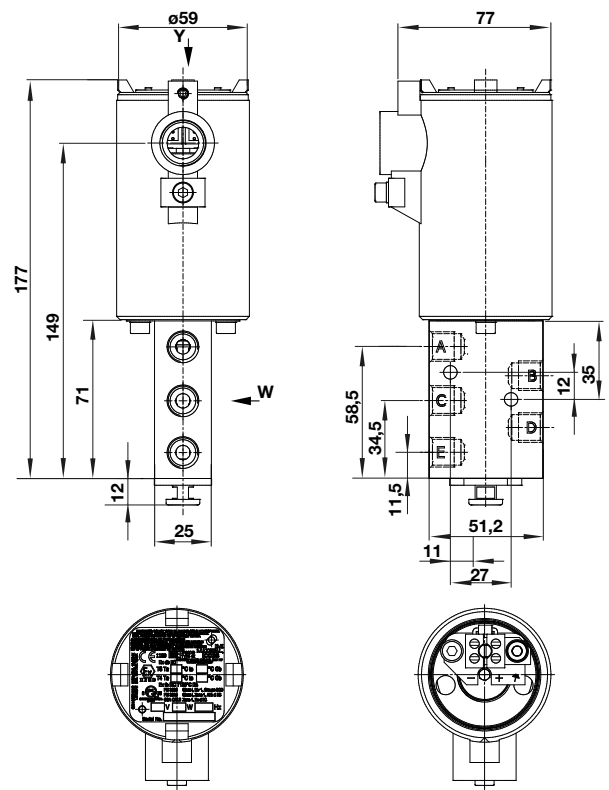
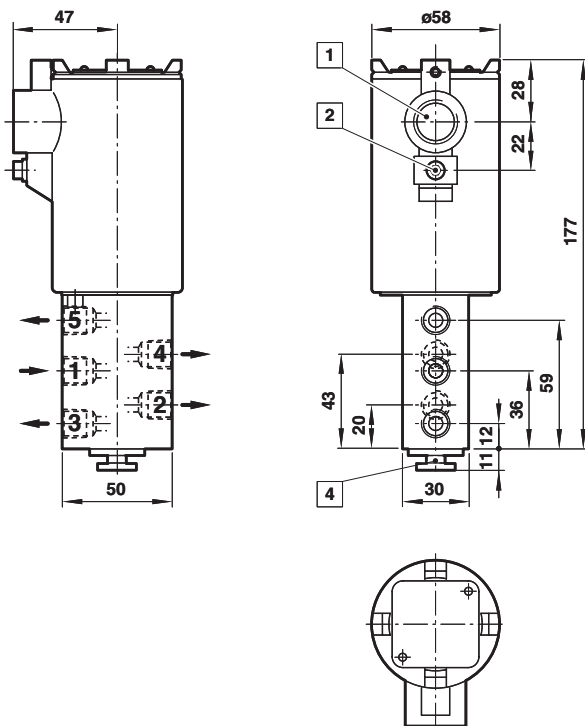
11

12

13

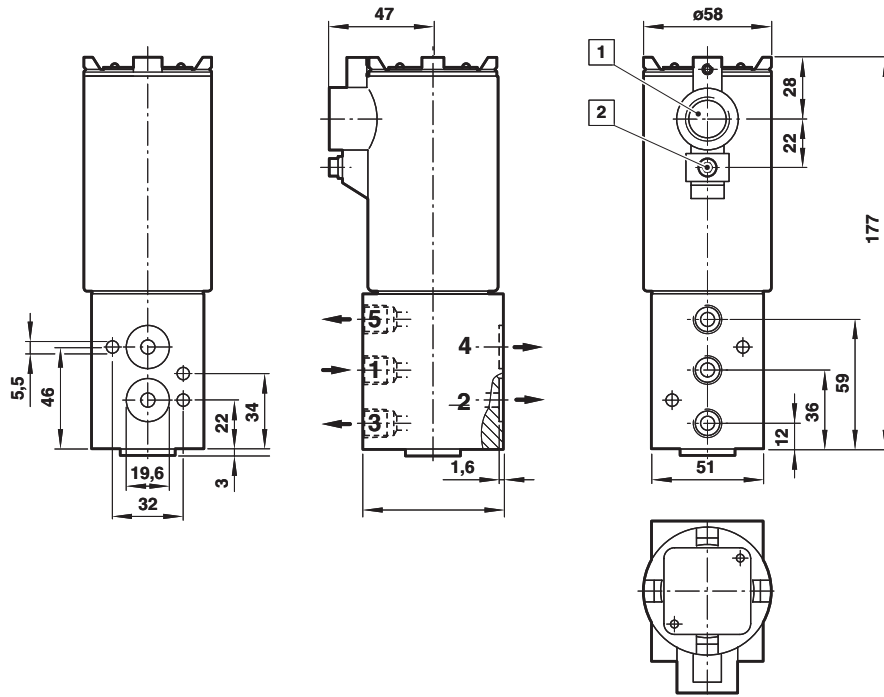
- 1 Conduit connection M20 x 1,5 or 1/2 NPT
- 2 External earth
- 3 Manual override PBMO
- 4 Manual override PBMR

14



Dimensions in mm
Projection/First angle



- 1 Conduit connection M20 x 1,5 or 1/2 NPT
- 2 External earth

Warning

These products are intended for use in industrial compressed air systems only. Do not use these products where pressures and temperatures can exceed those listed under

»Technical features/data«.

Before using these products with fluids other than those specified, for non-industrial applications, life-support systems or other applications not within published specifications, consult IMI Precision Engineering, Thompson Valves Ltd. Through misuse, age, or malfunction, components used in fluid power systems can fail in various modes.

The system designer is warned to consider the failure modes of all component parts used in fluid power systems and to provide adequate safeguards to prevent personal injury or damage to equipment in the event of such failure.

System designers must provide a warning to end users in the system instructional manual if protection against a failure mode cannot be adequately provided.

System designers and end users are cautioned to review specific warnings found in instruction sheets packed and shipped with these products.